

8

BPS

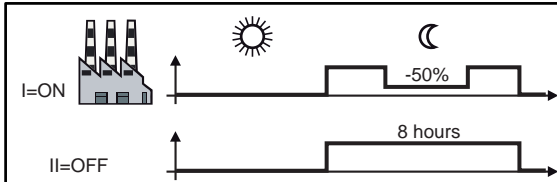
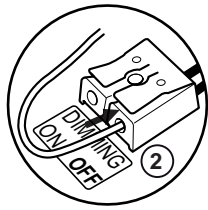
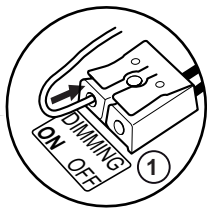
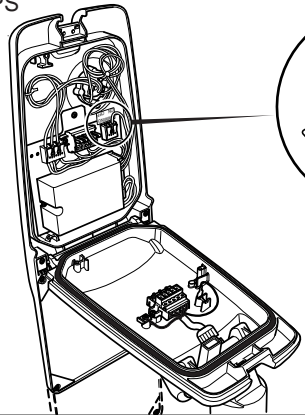

9

ISARO PRO RFxx

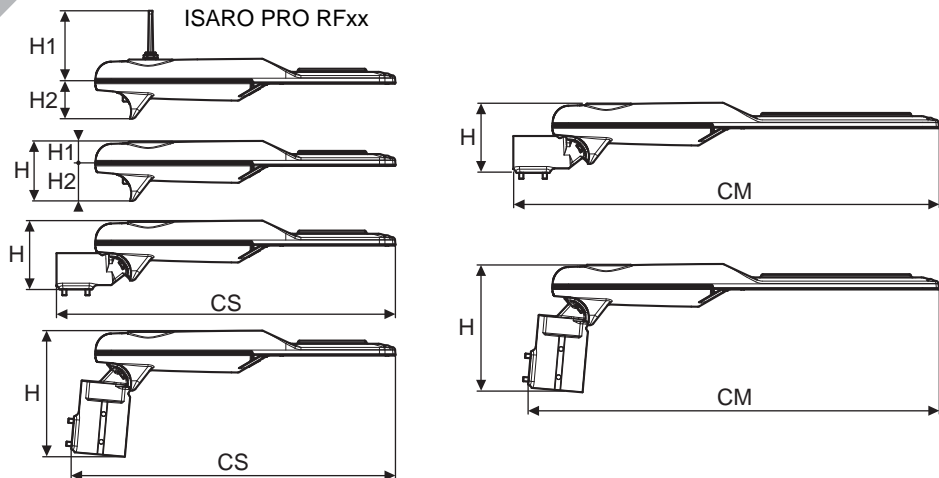
**FRANCAIS**

-Remplacer toute protection fissurée.
-Les luminaires classe II doivent être installés de façon à ce que la partie métallique ne soit pas en contact avec l'installation électrique connectée à la terre.

ATTENTION: Les luminaires classe I doivent être reliés à la terre.
-Ce luminaire fonctionne à une tension nominale qui doit être coupée avant toute intervention sur l'appareillage.
-Toute modification de cet appareil est interdite.
-Respecter la distance minimale par rapport aux objets éclairés définie par ce sigle.

**SVERIGE**

-Ersätta alla spräckta skyddsplåtar.
-Klass II armaturer måste installeras så att nakna metalldelar i armaturen inte är i kontakt med någon elektrisk installation, kopplad till en skyddledare.

WARNING: Klass I armaturer måste vara jordade.
-Denna armatur fungerar med högspänning som måste vara fränslagen före ingripande i driftöden.
-Alla ändringar i denna armatur är förbjuden.

ITALIANO

-Sostituire sempre tutte le protezioni danneggiate.
-Gli apparecchi in classe II devono essere installati in modo che le parti metalliche non siano in contatto con apparati elettrici collegati a terra.

ATTENZIONE: Gli apparecchi in class I devono essere collegati a terra.
-Questo apparecchio funziona a tensione nominale, questa deve essere interrotta prima di ogni intervento sul gruppo di alimentazione.
-Ogni modifica dell' apparecchio è proibita.

SUOMI

-Rikkoontunut suojaasi vaihdettava välittömästi uuteen vastaavaan.
-Asennettaessa suojausluokan II valaisinta on peruseristetyt johdot ja kosketteltavien metalliosien välinen kosketus tehokkaasti eristettävä.

VAROITUS: Suojausluokan I valaisin täytyy maadoittaa.
-Verkköjännite on kytkettävä pois ennen valaisimen huolto- ja korjauksia.
-Valaisimen rakennetta ei saa muuttaa.

DEUTSCH

-Ersetze jede gebrochene Schutzscheibe.
-Schutzklasse II Leuchten müssen so installiert werden, daß berührbare Metallteile nicht mit einem, an dem Schutzleiter angeschlossenen Teil der elektrischen Installation in Kontakt kommen.

ACHTUNG: Schutzklasse I Leuchten müssen geerdet sein.
-Diese Leuchte wird mit Netzspannung betrieben. Bevor Eingriffe am Vorschaltgerät vorgenommen werden sowie vor Wartung und Installation, ist die Versorgungsspannung abzuschalten.
-Jede Änderung an dieser Leuchte ist verboten.

ENGLISH

-Replace any cracked protective shield.
-Class II luminaires must be installed so that exposed metal work of the luminaire is not in contact with any part of the electrical installation connected to a protective conductor.

WARNING: Class I luminaires must be earthed.
-This luminaire operates at mains voltage which must be switched off before intervention in control gear.
-Any modification to this luminaire is forbidden.
-Lighted objects nearer than the minimal distance in the is forbidden.



ISARO PRO

THORN

UK Installation instructions

DE Montageanleitung

CZ Montážní návod

DK Monteringsvejledning

EE Paigaldusjuhend

FI Asennusohje

FR Notice de montage

HU Szerelési útmutató

IT Istruzioni di montaggio

LT Montavimo Instrukcijos

LV Instalācijas instrukcija

NO Monteringsanvisning

PL Instrukcja montażu

SE Installationsanvisning

RU ИНСТРУКЦИЯ ПО МОНТАЖУ

TYPE : ISARO PRO

ISARO PRO S

ISARO PRO M

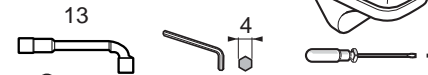
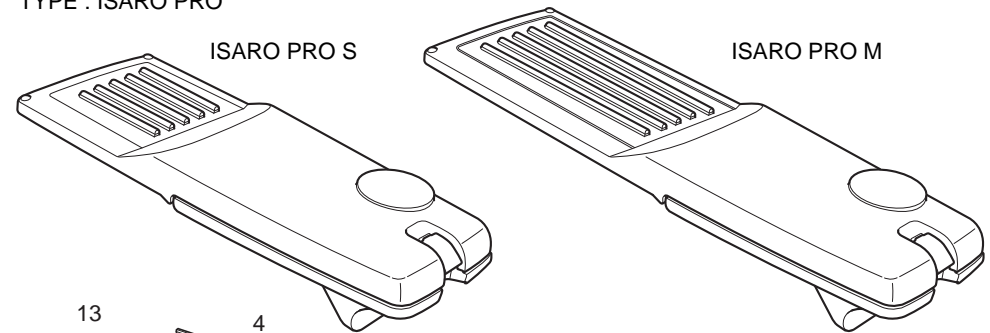

CLASS I

CLASS II

IK09 CE IP66

1

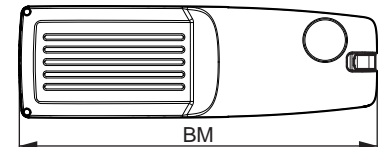
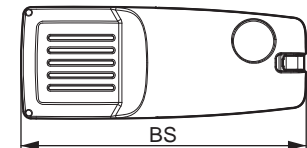
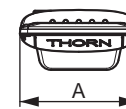
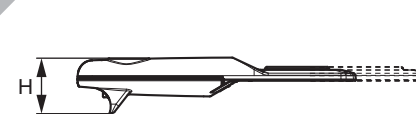

The luminaire with clear optic should be positioned so that prolonged staring into the luminaire at a distance <2 m is not expected.

The light of this luminaire is not replaceable; when the light source reaches its end of life, the whole lighting part shall be replaced.

ISARO PRO

	A	BS	BM	CS	CM	H	H1	H2	S (kg)	M (kg)	S SCx (m ²)	M SCx (m ²)
	224	571	718	-	-	114	41.7	72.3	-	-	0,054	0,066
	224	571	718	617	764	240	-	-	5,3	7,5	0,054	0,066
	224	571	718	645	792	131	-	-	5,2	7,4	0,054	0,066
	224	571	718	-	-	-	133	72.3	-	-	0,054	0,066

