

DATENBLATT

Modular-Adapter D-Sub09 Buchse / RJ45 Buchse

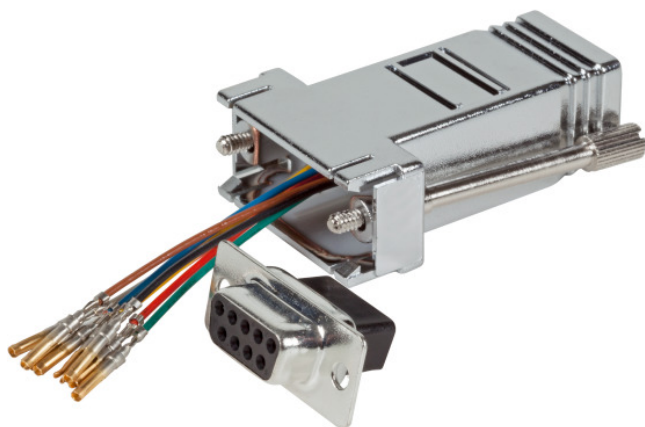

Beschreibung

Adapter zur individuellen Eigenbelegung
 D-Sub Stecker an RJ45 8P8C Buchse
 Metallisiertes Gehäuse
 Auf Anfrage auch fertig konfektioniert in Wunschbelegung lieferbar

Allgemeine Daten

Kategorie	sonstige
Bauform	gerade
Steckverbindertyp	sonstige
Ausführung	Stecker/Buchse
Befestigungsart	sonstige

Verfügbare Varianten

Art.Nr.	Bezeichnung	Geschirmt
ETM23055	Modular-Adapter D-Sub25 Buchse / RJ45 Buchse, metallisiertes Gehäuse	Ja
ETM23067	Modular-Adapter D-Sub09 Buchse / RJ45 Buchse, metallisiertes Gehäuse	Ja

Dieses Datenblatt wurde maschinell am 24-08-2020 erzeugt. Technische Änderungen vorbehalten.









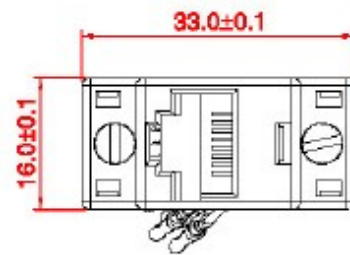
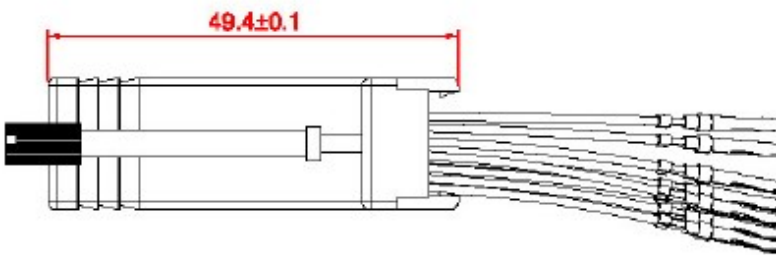
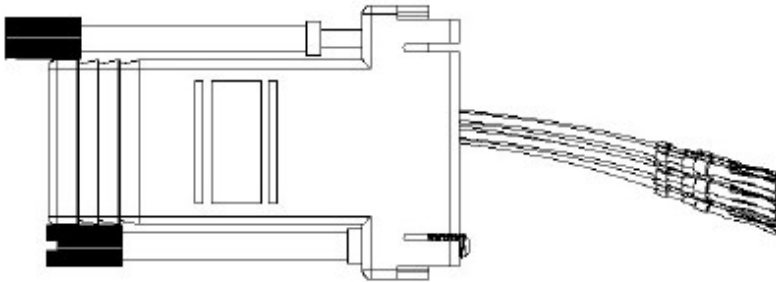

DATENBLATT

Modular-Adapter D-Sub09 Buchse / RJ45 Buchse

Abbildungen

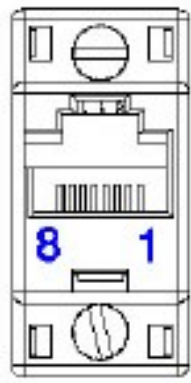

WIRE MAP			 Receptacle Crimp Contacts
P1		BLUE	
P2		ORANGE	
P3		BLACK	
P4		RED	
P5		GREEN	
P6		YELLOW	
P7		BROWN	
P8		GRAY	

RJ 45 JACK

UL1061

Dieses Datenblatt wurde maschinell am 24-08-2020 erzeugt. Technische Änderungen vorbehalten.



DATENBLATT

Modular-Adapter D-Sub09 Buchse / RJ45 Buchse

Abbildungen

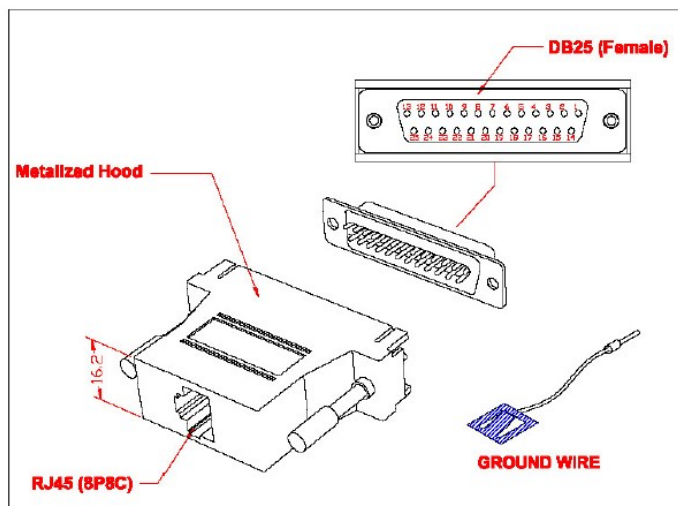
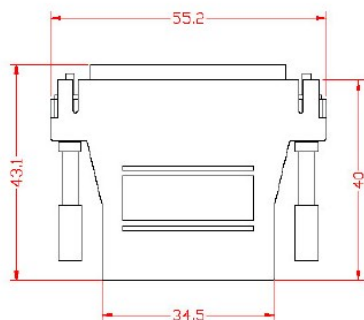

Dieses Datenblatt wurde maschinell am 24-08-2020 erzeugt. Technische Änderungen vorbehalten.

