

Other Protistor® Fuses DIN Bracket Ferrule Fuses 17x49 gRB/URB - 690 VAC

German standard without blown fuse indication

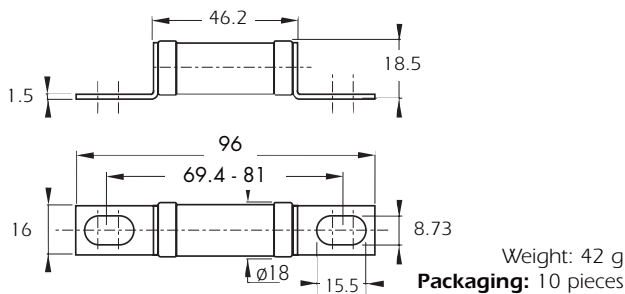

German standard with separate trip-indicator DIN 43623/00C

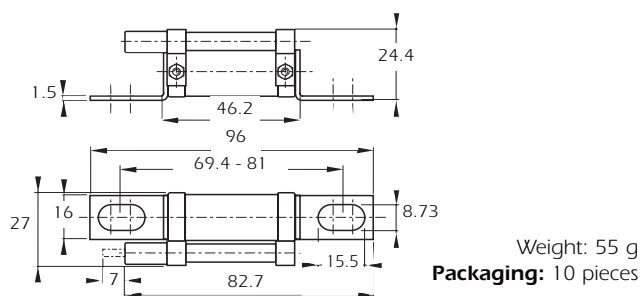

British standard without blown fuse indication

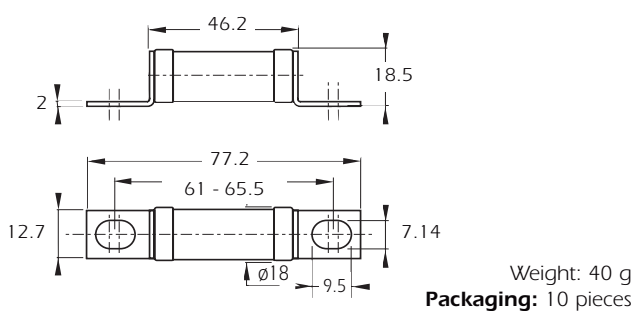

British standard with separate trip-indicator BS 88-4

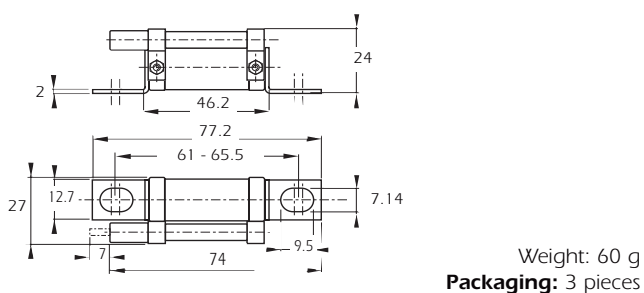

Current rating	Designation	Ref. Number	Catalog Number
12	6,9 gRB 17 D08/12	M220972	DN17GB69V12
16	6,9 gRB 17 D08/16	N220973	DN17GB69V16
20	6,9 gRB 17 D08/20	P220974	DN17GB69V20
25	6,9 gRB 17 D08/25	Q220975	DN17GB69V25
32	6,9 gRB 17 D08/32	R220976	DN17GB69V32
35	6,9 gRB 17 D08/35	S220977	DN17GB69V35
40	6,9 gRB 17 D08/40	T220978	DN17GB69V40
45	6,9 gRB 17 D08/45	V220979	DN17GB69V45
50	6,9 gRB 17 D08/50	W220980	DN17GB69V50
55	6,9 gRB 17 D08/55	X220981	DN17GB69V55
63	6,9 gRB 17 D08/63	Y220982	DN17GB69V63
75	6,9 gRB 17 D08/75	Z220983	DN17GB69V75
80	6,9 gRB 17 D08/80	A220984	DN17GB69V80
90	6,9 gRB 17 D08/90	B220985	DN17GB69V90
100	6,9 URB 17 D08/100	C220986	DN17UB69V100

Current rating	Designation	Ref. Number	Catalog Number
12	6,9 gRB 17 D08P 12	X221004	DN17GB69V12P
16	6,9 gRB 17 D08P 16	Y221005	DN17GB69V16P
20	6,9 gRB 17 D08P 20	Z221006	DN17GB69V20P
25	6,9 gRB 17 D08P 25	A221007	DN17GB69V25P
32	6,9 gRB 17 D08P 32	B221008	DN17GB69V32P
35	6,9 gRB 17 D08P 35	C221009	DN17GB69V35P
40	6,9 gRB 17 D08P 40	D221010	DN17GB69V40P
45	6,9 gRB 17 D08P 45	E221011	DN17GB69V45P
50	6,9 gRB 17 D08P 50	F221012	DN17GB69V50P
55	6,9 gRB 17 D08P 55	G221013	DN17GB69V55P
63	6,9 gRB 17 D08P 63	H221014	DN17GB69V63P
75	6,9 gRB 17 D08P 75	J221015	DN17GB69V75P
80	6,9 gRB 17 D08P 80	K221016	DN17GB69V80P
90	6,9 gRB 17 D08P 90	L221017	DN17GB69V90P
100	6,9 URB 17 D08P 100	M221018	DN17UB69V100P

Current rating	Designation	Ref. Number	Catalog Number
12	6,9 gRB 17/12	W220957	BS17GB69V12
16	6,9 gRB 17/16	X220958	BS17GB69V16
20	6,9 gRB 17/20	Y220959	BS17GB69V20
25	6,9 gRB 17/25	Z220960	BS17GB69V25
32	6,9 gRB 17/32	A220961	BS17GB69V32
35	6,9 gRB 17/35	B220962	BS17GB69V35
40	6,9 gRB 17/40	C220963	BS17GB69V40
45	6,9 gRB 17/45	D220964	BS17GB69V45
50	6,9 gRB 17/50	E220965	BS17GB69V50
55	6,9 gRB 17/55	F220966	BS17GB69V55
63	6,9 gRB 17/63	G220967	BS17GB69V63
75	6,9 gRB 17/75	H220968	BS17GB69V75
80	6,9 gRB 17/80	J220969	BS17GB69V80
90	6,9 gRB 17/90	K220970	BS17GB69V90
100	6,9 URB 17/100	L220971	BS17UB69V100

Current rating	Designation	Ref. Number	Catalog Number
12	6,9 gRB 17P12	D220987	BS17GB69V12P
16	6,9 gRB 17P16	E220988	BS17GB69V16P
20	6,9 gRB 17P20	F220989	BS17GB69V20P
25	6,9 gRB 17P25	G220990	BS17GB69V25P
32	6,9 gRB 17P32	H220991	BS17GB69V32P
35	6,9 gRB 17P35	J220992	BS17GB69V35P
40	6,9 gRB 17P40	K220993	BS17GB69V40P
45	6,9 gRB 17P45	L220994	BS17GB69V45P
50	6,9 gRB 17P50	M220995	BS17GB69V50P
55	6,9 gRB 17P55	N220996	BS17GB69V55P
63	6,9 gRB 17P63	P220997	BS17GB69V63P
75	6,9 gRB 17P75	Q220998	BS17GB69V75P
80	6,9 gRB 17P80	R220999	BS17GB69V80P
90	6,9 gRB 17P90	S221000	BS17GB69V90P
100	6,9 URB 17P100	T221001	BS17UB69V100P

Other Protistor® Fuses DIN Bracket Ferrule Fuses 17x49 gRB/URB - 690 VAC

Total clearing I²t

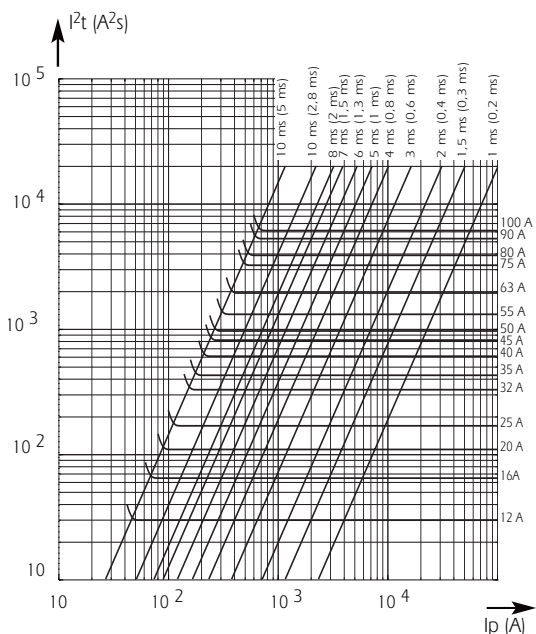

Above: Horizontal curves show for each rated current maximum values of total clearing I^2t (I^2t_t) as a function of prospective current I_p . @ 690 V. $\cos \varphi = 0.15$.
Oblique lines indicate total clearing duration T_t and associated pre-arcing duration in brackets.

Time vs current characteristics

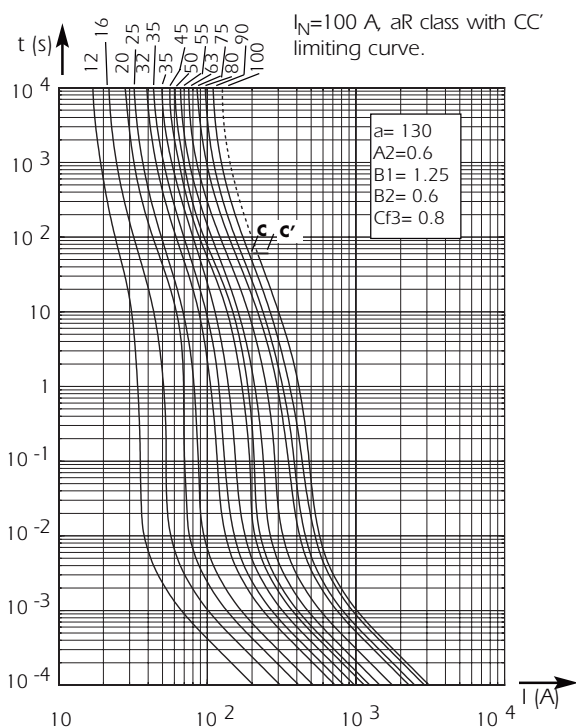

Tolerance for mean pre-arcing current $\pm 9\%$.

Above: Curves indicate, for each rated current, pre-arcing time vs. R.M.S. pre-arcing current

I²t corrective factor

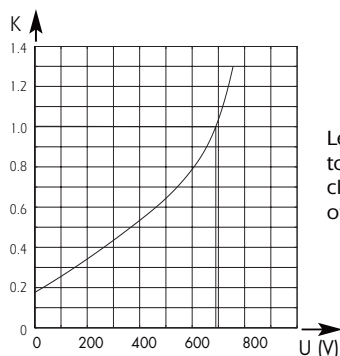

Left: Curve shows variation of total clearing time (I^2t_t) and total clearing duration T_t as a function of operating voltage U .

Peak arc voltage

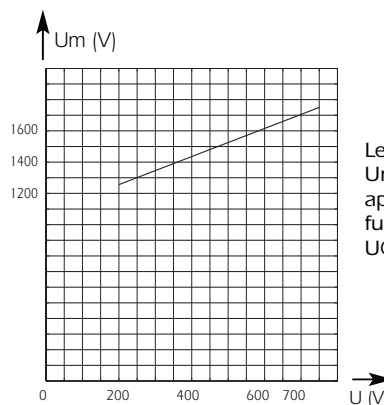

Left: Curve shows peak value U_m of arc voltage which appears across fuse-link as a function of operating voltage U @ $\cos \varphi = 0.15$

Current limitation curves

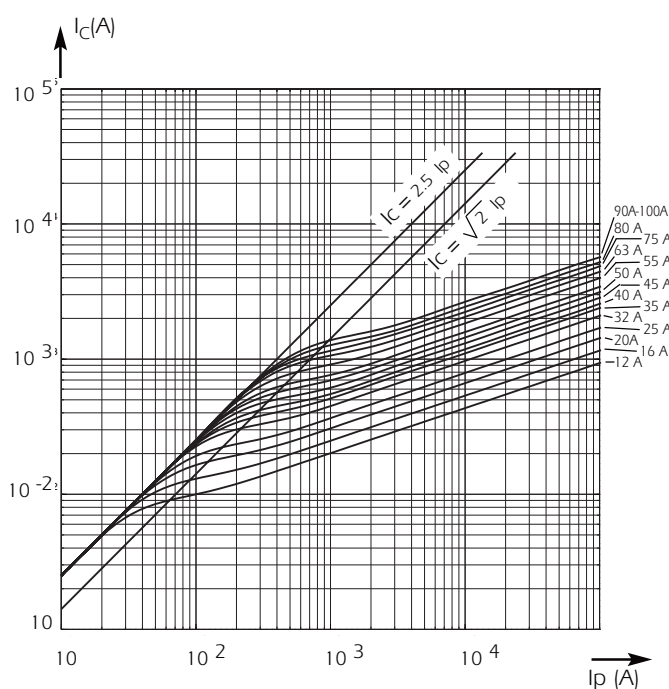

Above: Curves show, for each rating, value of peak let-through current I_c as a function of available fault current I_p .

Other Protistor® Fuses DIN Bracket Ferrule Fuses 17x49 gRB/URB - 690 VAC

DC Application data

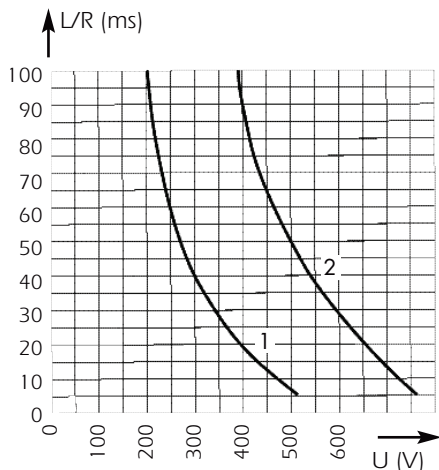

Above: Curves indicate permissible value of time constant L/R as a function of DC working voltage.
Curve 1: $I_p \geq 1,6$ IN only for fuses gRB (current rating from 12 to 50 A)
Curve 2: $I_p \geq 8$ IN for fuses gRB et URB

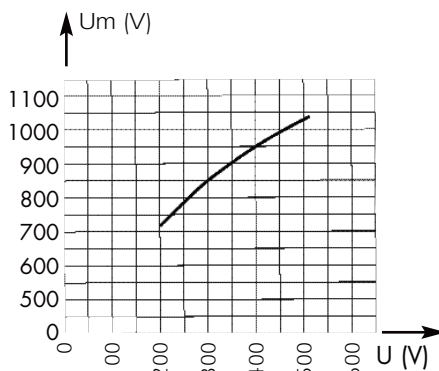

Curve indicates peak arc voltage U_m which may appear across the fuse terminals at working voltage U .

Microswitch

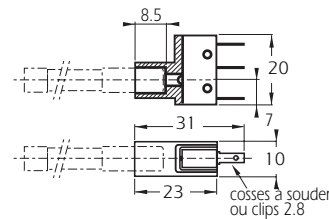

Designation	Ref. Num.	Weight	Pack.
MC 6,3 GR 2,5	Y 310015	10 g	3 pieces

Electrical characteristics:
 $I_N = 3$ A - $U_N = 250$ VAC
 $I_N = 2$ A - $U_N = 30$ VDC

Certain minimum operating voltage/current
20 V-100 mA

NEW gR-CLASS

OPTIMAL PROTECTION OF POWER EQUIPMENT

Thanks to recent technological developments, Ferraz Shawmut today markets gR-class PROTISTOR® fuses capable of clearing all types of overloads, from low multiples of current ratings up to very high short-circuit currents. Enhanced performance enables these fuses to provide solutions to many previously unsolved problems in power electronics: protection of cables without the use of additional components, protection of equipment from fire hazards, selective coordination of different fuses within a single power distribution installation...

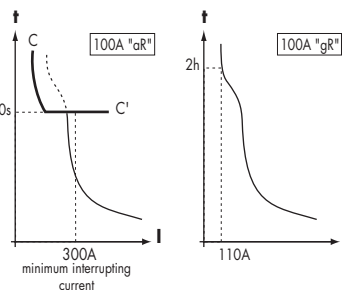

Example:
100A aR vs. 100A gR

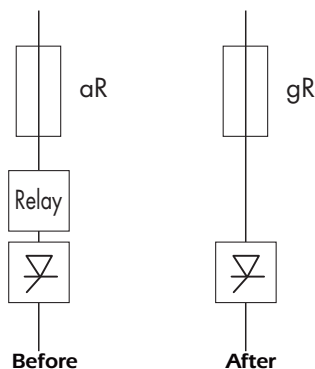

SELECTIVE COORDINATION

gR-class semiconductor fuses can be utilized in association with gI and gG-class low voltage power distribution fuses of the same current rating, installed upstream. In a "selectively coordinated" distribution installation, melting is limited to the fuse associated with the faulted circuit, while upstream fuses remain intact. This prevents unnecessary down-time due to power blackouts in non-faulted branches.

Example of selective coordination

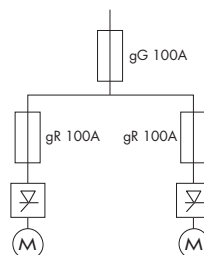

aR-CLASS vs. gR-CLASS

aR-class fuses feature a high minimum interrupting current as compared with their current rating. The primary time-current characteristic of aR-class fuses is the CC' curve, above which another protection device must be associated. The gR-class fuse represents considerably improved performance in semiconductor protection.

FERRAZ SHAWMUT EXPERTISE

gR-class fuses should be used in the design of low voltage equipment and in the protection of power electronics equipment. Designers can often substitute a gR-class fuse for an aR-class fuse (10x38, 14x51, 22x58, PSC 000 and 17x49 DIN80 or BS 88-4) but the reverse is not true: an aR fuse can never replace a gR fuse. Start protecting your new equipment with gR-class fuses today. The application of gR class fuses, with current ratings less than 100 Amps, offers enhanced protection, safety and reliability, along with reduced risk of replacement errors and assembly costs.