

# LK-L 060.10830.1125.U19/DALI



## Beschreibung

- Lichteinsatz mit integrierten LED-Lichtstreifen für 360° blendfreie Arbeitsplatzbeleuchtung (UGR < 19)
- Reflektor aus verkehrsweiß lackiertem Aluminiumblech
- Entblendungskollimatoren aus Polycarbonat
- keine UV- und Wärmestrahlung
- nahezu alle Lichtbandlängen realisierbar
- inklusive Leitung-Set (5-polig)
- PMMA-Mattfolie für gleichmäßige Lichtverteilung
- werkzeugloses Einrasten in Lichtkanal-Profil über Einbaufedern
- 5-polige Anschlussklemme, konfektioniert für Durchgangsverdrahtung
- Betriebsgerät (LED-Konverter DALI, dimmbar) integriert

## Hinweise

Verwendung nur in Verbindung mit Lichtlenkungsfolien nanoOptix "tiefstrahlend" (STRL-LK060-Z 690.DB), "Batwing und breitstrahlend" (STRL-LK060-Z 690.BW-WB) sowie "Wallwasher" (STRL-LK060-Z 690.WW). Die thermische Längenausdehnung des Aluminiumprofils beträgt bei  $dT = 10$  Kelvin 0.3 mm pro Meter.

Farbe	Artikelnummer	EAN
	667941	4043544795885

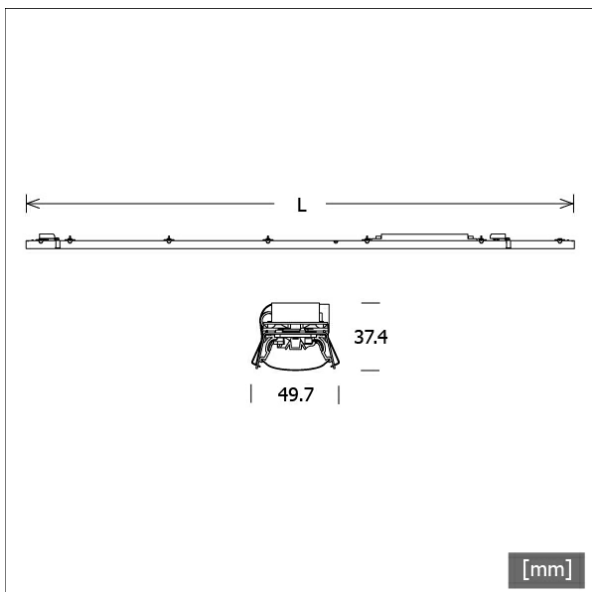

## Standardoptionen



## Lichttechnik / Normen

Leuchtmittel	LED linear / CRI 80 / 3000 K
Lebensdauer	L90 B50 50.000 h L80 B50 100.000 h L80 B20 50.000 h
Systemleistung	12.0 W
Leuchten-Lichtstrom	max. 1790 lm
Systemeffizienz	147.93 lm/W
Moduleffizienz	193.00 lm/W
UGR Klasse	≤19
Versorgungsspannung	220 - 240 V / 50 - 60 Hz
Schutzklasse	I

## Abmessungen / Gewichte

Länge	1125 mm
Breite	50 mm
Höhe	37 mm
Nettogewicht	0.96 kg
Bruttogewicht	1.01 kg

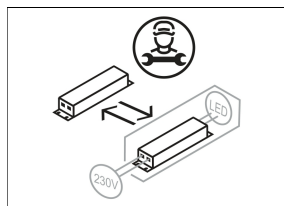
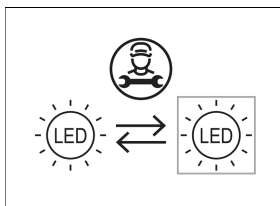

# LK-L 060.10830.1125.U19/DALI

## LK-L 060.10830.1125.U19/DALI

Lichtkanal 060 | Light-Insert (Deep Beam nanoOptix, 1xLED 12W 830/3000K 1790lm)

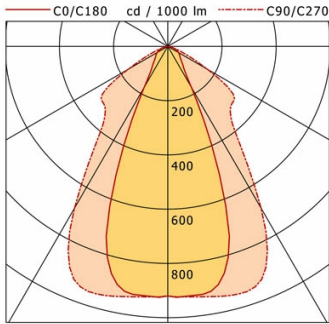

	C0	C90	C180	C270
0°	920	920	920	920
15°	838	948	838	948
30°	174	689	174	689
45°	68	326	68	326
60°	45	170	45	170
75°	20	20	20	20
90°	0	0	0	0

cd / 1000 lm

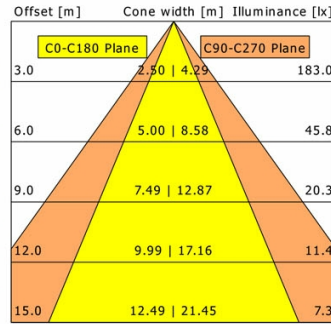

<b>η</b>	LED
Efficiency	149 lm/W
Direct/Indirect	↓ 100% / ↑ 0%
System Power	12 W
<b>UGR</b>	X=4H, Y=8H
Reflection factors	70/50/20
UGR C0/C180	16.2
UGR C90/C270	19.0
CIE Flux Codes	80 94 99 100 100
Ra/CRI	>80

LTS

## LK-L 060.10830.1125.U19/DALI

Lichtkanal 060 | Light-Insert (Batwing/Wide Beam nanoOptix, 1xLED 12W 830/3000K 1760lm)

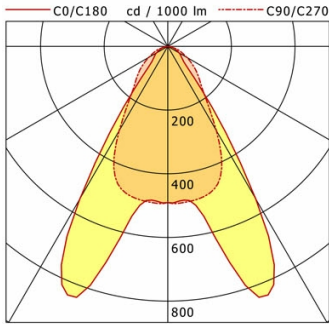

	C0	C90	C180	C270
0°	491	491	491	491
15°	663	482	663	482
30°	553	306	553	306
45°	75	138	75	138
60°	41	69	41	69
75°	17	23	17	23
90°	0	0	0	0

cd / 1000 lm

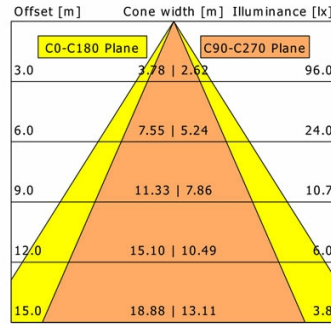

<b>η</b>	LED
Efficiency	147 lm/W
Direct/Indirect	↓ 100% / ↑ 0%
System Power	12 W
<b>UGR</b>	X=4H, Y=8H
Reflection factors	70/50/20
UGR C0/C180	16.7
UGR C90/C270	19.2
CIE Flux Codes	77 94 99 100 100
Ra/CRI	>80

LTS

## LK-L 060.10830.1125.U19/DALI

Lichtkanal 060 | Light-Insert (Wallwasher nanoOptix, 1xLED 12W 830/3000K 1720lm)

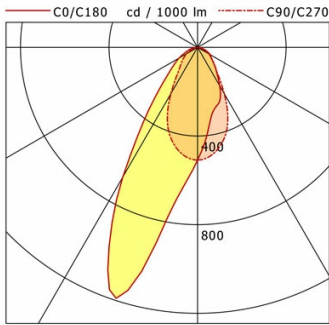

	C0	C90	C180	C270
0°	509	509	509	509
15°	290	440	1096	440
30°	200	242	676	242
45°	104	106	214	106
60°	66	57	96	57
75°	28	18	37	18
90°	0	0	0	0

cd / 1000 lm

LDC unsuitable for cone representation.  
Asymmetric LDC.

<b>η</b>	LED
Efficiency	143 lm/W
Direct/Indirect	↓ 100% / ↑ 0%
System Power	12 W
<b>UGR</b>	X=4H, Y=8H
Reflection factors	70/50/20
UGR C0/C180	18.6
UGR C90/C270	19.2
CIE Flux Codes	69 90 98 100 100
Ra/CRI	>80

LTS