

Maßskizze / dimensional drawing

Benennung: Anbausteckdose schräg IP44 75x85 TT

description: Flanged socket sloping IP44 75x85 TT

Teilenummer / part number: 413-*tff87, 414-*tff87, 415-*tff87

PCE

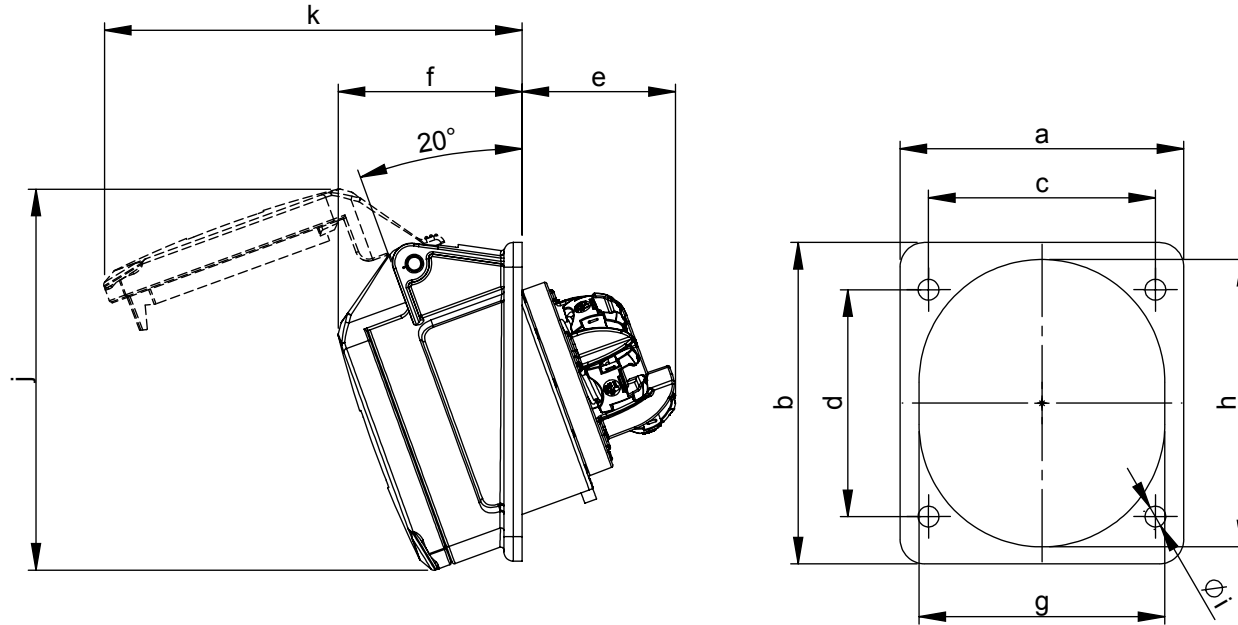

Ampere	16		
Pole	3	4	5
a [mm]	75	75	75
b [mm]	85	85	85
c x d [mm]	60	60	60
e [mm]	41	41	41
f [mm]	47	47	48
g [mm]	51	56	65
h [mm]	61	67	76
i [mm]	5,5	5,5	5,5
j [mm]	85	96	101
k [mm]	99	104	111