







separately enclosed:

-  4x fillister head cup screw M5x12 (SW4)
-  4x washer M5
-  4x fillister head cup screw M4x10 (SW3)
-  4x washer M4

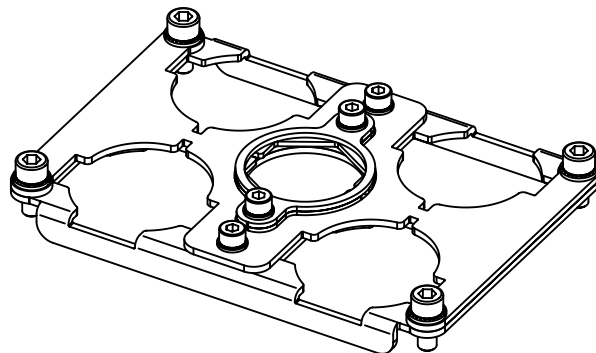

	 All Dimensions in mm Original Size DIN A4	Scale 1:2	Free size tol.		Ref. Sub. TB 09 40 048 9913 v. 29.05.07	
	All rights reserved Department EL PD - DE	Created by HOLLERT	Inspected by SCHNIEDER	Standardisation TIEMANNA	Date 2014-07-08	State Final Release
HARTING Electric GmbH & Co. KG D-32339 Espelkamp		Title Han 48HPR-F frame for (4xHC650/1XHC350)			Doc-Key / ECM-Nr. 100108163/UGD/005/A 500000076488	
		Type TB	Number 09 40 048 9913		Rev. A	Page 1/1